

SPECIFICATIONS

- UNIVERSAL 6-IN-1 LATCH: DRIVE IN, SQUARE MORTISE AND RADIUS CORNER WITH ADJUSTABLE BACKSET: 2-3/8" (60 mm) – 2-3/4" (70 mm)
- STANDARD BORE HOLES: 2-1/8" (54 mm)
- FITS STANDARD DOOR THICKNESS: 1-3/8" (35 mm) – 1-3/4" (45 mm)
- FULL LIP RADIUS CORNER STRIKE WITH ADJUSTABLE TAB STANDARD: 1-3/4" x 2-1/4" (45 mm x 57 mm)
- PUSH BUTTON AUTO-RELEASE ON PRIVACY FUNCTION

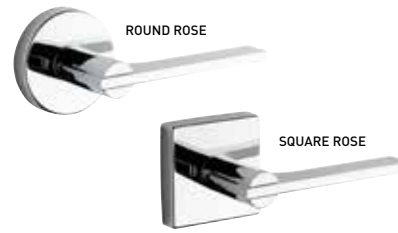

GRADE 3
ANSI GRADE 3



LIFETIME MECHANICAL & FINISH WARRANTY

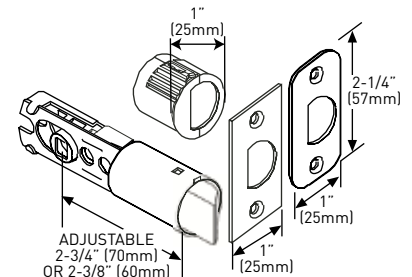
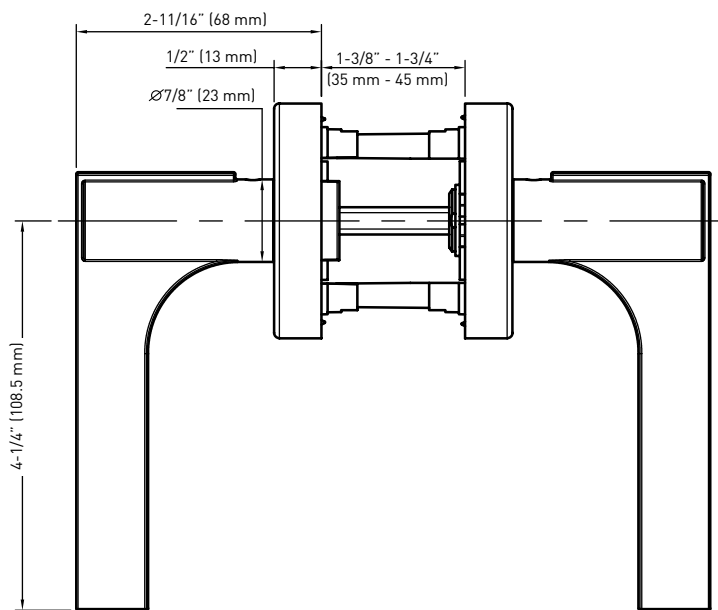
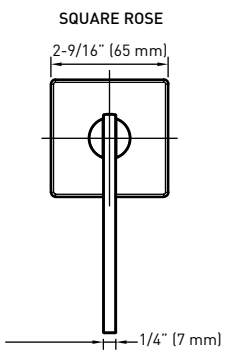
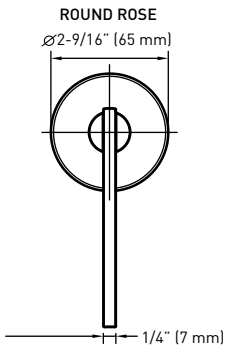
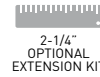

6-IN-1 PRIVACY/PASSAGE LATCH

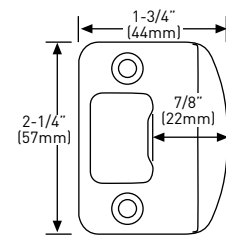

FULL LIP RADIUS STRIKE

MEASUREMENTS SUBJECT TO A 3% VARIANCE

MEASUREMENTS ARE FOR REFERENCE ONLY. TAYMOR RESERVES THE RIGHT TO CHANGE THE PRODUCT SPECS WITHOUT NOTICE. FOR PRODUCT WARRANTY, PLEASE VISIT TAYMOR WEBSITE FOR DETAILS

ARC DECO - ROUND ROSE

BUILDER PACK	PRIVACY	PASSAGE	DUMMY	CASE QTY.
SATIN NICKEL 15	30-D007424SN	30-D007434SN	30-744SN	20
MATTE BLACK 19	30-D007424BLK	30-D007434BLK	30-744BLK	20
POLISHED CHROME 26	30-D007424PC	30-D007434PC	30-744PC	20

ARC DECO - SQUARE ROSE

BUILDER PACK	PRIVACY	PASSAGE	DUMMY	CASE QTY.
SATIN NICKEL 15	30-D007524SN	30-D007534SN	30-754SN	20
MATTE BLACK 19	30-D007524BLK	30-D007534BLK	30-754BLK	20
POLISHED CHROME 26	30-D007524PC	30-D007534PC	30-754PC	20

